

FOCUS[®]
LIGHTING & FIXTURES LTD

PLUS[®]
LIGHT TECH

TRIX[®]

L&B[®] Lumens
& Beyond

Corporate Office

Focus Lighting & Fixtures Ltd.
1007-1010, Corporate Avenue,
Sonawala Road, Goregaon(E),
Mumbai-400063. India.

T +91-22-2686 5671 -5

E info@trix.co.in

Work

Focus Lighting & Fixtures Ltd.
Survey No.396/24, Plot no.71/72,
New Ahmedabad Industrial estate,
NH 8A, Moraiya,
Dist. Sanand, Gujarat -382210

T +91-22-2686 5671 -5

UAE Office

Block D1-19, Free Zone gate -1,
AL Bustan, Ajman Free Zone.
PO Box- 28555.
Dubai, UAE.

T +971 - 67449598

www.trix.co.in

TRIX[®]

PRODUCT **24**
SHOWCASE
illuminating lives smartly



MGT-23 Magnetic series

Magnetic Lighting is a low voltage system for indoor lighting. It consists of an assembly that can hold various light sources while using magnetic attraction. The magnetic track lighting system can have various lengths, shades and sizes. A magnet track can support different led lights, so it can be used in a wider range of applications. It can slide to any position easily without any auxiliary tools. Magnetic track light is a combined product, mainly composed of three parts: track, light body and switching power supply. Through the magnetic technology, the lamp components are adsorbed on the track.

The magnetic track is generally DC48V safety voltage, under normal circumstances, harmless to humans.



MGT23 - TS

Magnetic Cylinder Trackspot

The Magnetic track spotlights are based on LED track lights with track heads with magnets, with low-voltage DC48V input. The Spot fixture is made of die cast aluminium with built in DCDC converters. Suitable for kitchen room, dining room, and wall washer lighting.

Beam Angle : 24° / CRI: 90

Driver : Track Integrated

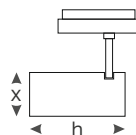

IP20	WW
	NW
	CW

Watt	Lumens
5W	500lm
10W	1000lm
15W	1500lm
24W	2400lm

Dia(x)	Ht(h)
35	80
45	100
55	120
65	140

MGT23 - WWG

Magnetic Grill Wallwasher

Magnetic die cast aluminium wallwasher is adjustable spotlight is designed as grid spotlight. It is adjustable to required degree & can also be used as 90° adjustment as non-directional lighting. DALI/Smart dimmable options available.

Beam Angle : 24° / CRI: 90

Driver : Track Integrated

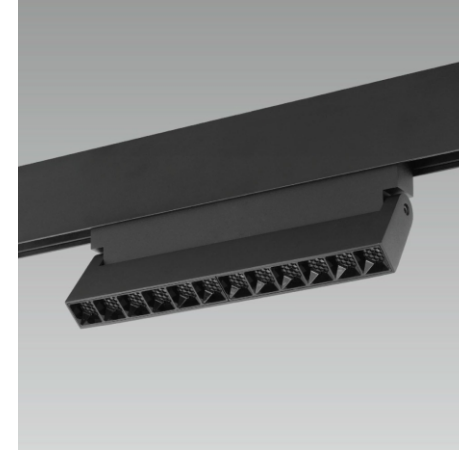

IP20	WW
	NW
	CW

Watt	Lumens
6W	600lm
12W	1200lm

L(x)	B(b)	Ht(h)
112	23	113
220	23	113

MGT23 - RS

Magnetic Sphere Trackspot

Die cast aluminium round magnetic spotlight with focussed spotlight. Swivel option for more flexibility and better options to highlight the space or subject illumination. Suitable for interiors illumination and focusing on subjects.

Beam Angle : 24° / CRI: 90

Driver : Track Integrated

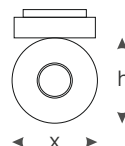

IP20	WW
	NW
	CW

Watt	Lumens
12W	1200lm

Dia(x)	Ht(h)
110	100

MGT23 - FXG

Magnetic Fixed Grill Downlight

The magnetic die cast aluminium grid spotlight is a directional lighting fixture with grill lens-based reflector with high CRI led. Suitable for use with magnetic line lights as basic lighting in the living room, dining room, corridor, etc.

Beam Angle : 24° / CRI: 90

Driver : Track Integrated

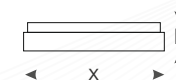

IP20	WW
	NW
	CW

Watt	Lumens
6W	600lm
12W	1200lm
18W	1800lm
24W	2400lm
36W	3600lm
54W	5400lm

L(x)	B(b)	Ht(h)
112	23	45
220	23	45
328	23	45
436	23	45
652	23	45
976	23	45

MGT23 - PDT RD

Magnetic Sphere Pendant

The magnetic die cast aluminium round sphere shape pendant light is a with hanging ropes for suspended installation as decorative lighting. It is generally used as auxiliary lighting and is mostly used in the room corners, bedside table, etc.

Beam Angle : 24° / CRI: 90
Driver : Integrated

IP20	WW
	NW
	CW

Watt	Lumens
12W	1200lm

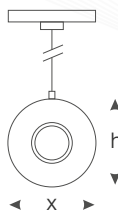

Dia(x)	Ht(h)
110	100

MGT23 - DWW

Magnetic Diffused Wallwasher

Magnetic linear diffuser adjustable die cast aluminium fixture with front PMMA diffuser. It has a wide distribution of 120° beam angle & high CRI. Suitable for wide spread focussing on Walls or structures or for general lighting in large spaces like halls, living rooms, offices, etc.

Beam Angle : Diffused / CRI: 90
Driver : Non-Integrated.

IP20	WW
	NW
	CW

Watt	Lumens
6W	600lm
12W	1200lm
18W	1800lm

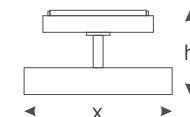

L(x)	B(b)	Ht(h)
112	23	113
220	23	113
328	23	113

MGT23 - DECO

Magnetic Decorative Pendant

The magnetic pendant light is a cylinder downlight with hanging ropes for suspended installation as decorative lighting & is made of die cast aluminium and glass. It spreads diffused light around 360D due to diffused glass.

Beam Angle : 24° / CRI: 90
Driver : Integrated

IP20	WW
	NW
	CW

Watt	Lumens
7W	700lm

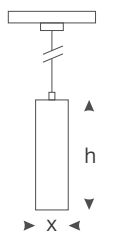
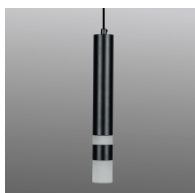

Dia(x)	Ht(h)
40	300

MGT23 - FXD

Magnetic linear Fixed Diffused

Magnetic linear diffuser die cast aluminium fixture with front PMMA diffuser. It has a wide distribution of 120° beam angle & high CRI for general lighting in large spaces like living rooms, offices, etc. with high CRI.

Beam Angle : Diffused / CRI: 90
Driver : Non-Integrated.

IP20	WW
	NW
	CW

Watt	Lumens
6W	600lm
12W	1200lm
18W	1800lm
24W	2400lm
36W	3600lm
54W	5400lm

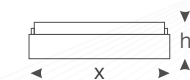
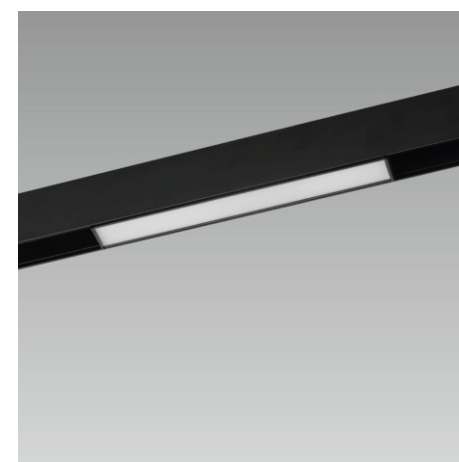

L(x)	B(b)	Ht(h)
112	23	45
220	23	45
328	23	45
436	23	45
652	23	45
976	23	45

MGT23 - PDT N

Magnetic Decorative Pendant

The magnetic pendant light is a die cast aluminium cylinder downlight with hanging ropes for suspended installation as decorative lighting. It is generally used as auxiliary lighting and is mostly used in the study room, bedside table / dining table or above the commercial billing counters.

Beam Angle : 24°, 36° / CRI: 90

Driver : Non-Integrated.

IP20

WW
NW
CW

Watt	Lumens
10W	1000lm

Dia(x)	Ht(h)
50	300



MGT23 - PDT D

Magnetic Decorative Pendant

The magnetic pendant light is a two step light source cylinder downlight with hanging ropes for suspended installation as decorative lighting. It is generally used as ambience pendant light and is mostly used in the study room, room corners, and above the dining table.

Beam Angle : Diffused / CRI: 90

Driver : Non-Integrated.

IP20

WW
NW
CW

Watt	Lumens
10W	1000lm

Dia(x)	Ht(h)
60	320



MAGNETIC TRACKS



TRIMLESS



RECESSED



DEEP SURFACE



LOW SURFACE

MAGNETIC TRACKS ACCESSORIES



Power Head



Straight Joint



Flexible Joint

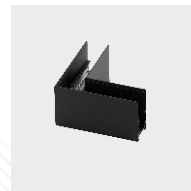

L Joint Surface

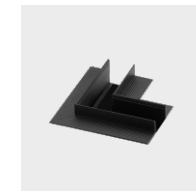

L Joint Recessed



Suspension Kit



Adapter Long



Adapter Small

*4 Wire Track. *Available Color - Black.

*Available in 1Mtr./2Mtr. Length

General Terms & Conditions:

Prices of all items in this price list are of standard luminaires & are inclusive of GST.

Prices are subject to change without prior Notice.

Product Photographs shown are indicative. Actual product may differ at time of supply.

While the product images, specifications and other details herein are represented to the best of graphic possibility, Focus Lighting and Fixtures Ltd. reserves the right to make technical and formal alterations to the products and specifications in the interest of development / improvement.

All technical parameters like Lm/W, Wattage etc, are subject to tolerance as per BIS standards.

Care has been taken to ensure that the information contained within is correct however company reserves the right to issue amendment's, which may arise due to any errors in price list.

All disputes are subject to Mumbai Jurisdiction only.

The copyrights of all designs, drawings, specifications and information contained in this catalogue are and shall remain the property of Focus Lighting and Fixtures Ltd. and must not be used, copied, published or divulged by any person in whole or in part without exclusive written authorisation from the **Focus Lighting and Fixtures Ltd.**

